



SENTRY-PRO POWER SYSTEMS

By Gillette Generators, Inc.

MODEL
SPH-100

AIR COOLED LPG/NG, RESIDENTIAL STANDBY GEN-SET

KW POWER RATINGS RANGE

Model SERIES	HZ	MAXIMUM 150°C RISE		STANDBY 125°C RISE		PRIME 105°C RISE	
		LPG	N.G.	LPG	N.G.	LPG	N.G.
SPH-100	60	10.0	9.5	10.0	9.0	9.0	8.0
	50	8.5	8.0	8.5	7.5	7.5	7.0

NOTE: Minimal KW derating due to an oversized prime mover.

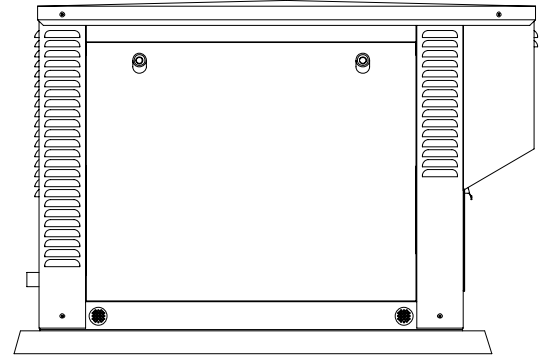

STANDARD FEATURES

- All generator sets are USA prototype built and thoroughly tested. Production models are USA factory built and 100% load tested.
- All generator sets will accept 100% rated load in one step, per NFPA-110.
- All generators are UL-1446 certified.
- Capacitor load compensated (CLC) voltage regulation for $\pm 3\%$ is standard on all gen-sets.
- Mechanical engine governor incorporates a special actuator, which allows precise 2% frequency regulation, from no load to full load.
- A brushless rotating field generator design with shunt wound excitation system and available at a broad range of voltages.
- Solid state, digital microprocessor logic and ultra-bright LED, annunciation display for different engine and generator functions, plus automatic fault shutdowns; high temp., over-crank, over-speed, under-speed, low oil, and low battery.
- The heavy duty, rugged dry fueled engine is capable of delivering rated power at 3600 RPM (60 HZ) or 3000 RPM (50 HZ).
- All generator set control systems components and accessories provide a 2-year limited warranty at time of initial start-up. Optional extended warranties are available. Generators and engines are governed by separate warranties.
- "OPEN" Generator Sets: There is no enclosure, so gen-set must be placed within a weather protected area, un-inhabited by humans or animals, with proper ventilation. Flexible exhaust hose is supplied loose for final exhaust pipe installation system, furnished by installer.
- "STANDARD" Housing: Full weather protection and average sound attenuation for normal applications.
- "SUPER-SILENT" Housing: Full weather protection and superior sound attenuation for specific low noise applications. (See "Sound Level" chart).

GENERATOR RATINGS

GENERATOR MODEL	VOLTAGE		PH	HZ	LIQUID PROPANE GAS FUEL						NATURAL GAS FUEL					
					150°C RISE MAXIMUM RATING		125°C RISE STANDBY RATING		105°C RISE PRIME RATING		150°C RISE MAXIMUM RATING		125°C RISE STANDBY RATING		105°C RISE PRIME RATING	
	L-N	L-L			KW/KVA	AMP	KW/KVA	AMP	KW/KVA	AMP	KW/KVA	AMP	KW/KVA	AMP	KW/KVA	AMP
SPH-100-1-1	120	240	1	60	10/10	42	10/10	42	9/9	37	9.5/9.5	40	9/9	37	8/8	33
SPH-100-3-2	120	208	3	60	10/12.5	35	10/12.5	35	9/11	31	9.5/11.8	33	9/11	31	8/10	28
SPH-100-3-3	120	240	3	60	10/12.5	30	10/12.5	30	9/11	27	9.5/11.8	28	9/11	27	8/10	24
SPH-100-3-4	277	480	3	60	10/12.5	15	10/12.5	15	9/11	13	9.5/11.8	14	9/11	13	8/10	12
SPH-100-3-5	127	220	3	60	10/12.5	33	10/12.5	33	9/11	30	9.5/11.8	31	9/11	30	8/10	26
SPH-100-1-6-5	110	220	1	50	8.5/8.5	39	8.5/8.5	39	7.5/7.5	34	8/8	36	7.5/7.5	34	7/7	32
SPH-100-3-7-5	110	220	3	50	8.5/10.5	28	8.5/10.5	28	7.5/9.5	24	8/10	26	7.5/9.5	24	7/8.8	23
SPH-100-3-8-5	219	380	3	50	8.5/10.5	16	8.5/10.5	16	7.5/9.5	14	8/10	15	7.5/9.5	14	7/8.8	13
SPH-100-3-9-5	240	415	3	50	8.5/10.5	15	8.5/10.5	15	7.5/9.5	13	8/10	14	7.5/9.5	13	7/8.8	12
SPH-100-3-10-5	231	400	3	50	8.5/10.5	15	8.5/10.5	15	7.5/9.5	13	8/10	15	7.5/9.5	13	7/8.8	13

RATINGS: All single phase gen-sets are rated at unity (1.0) power factor. All three phase gen-sets are rated at .8 power factor. "MAXIMUM RATINGS" are for short period running, not exceeding 1 hour. "STANDBY RATINGS" are strictly for gen-sets that are used for back-up emergency power to a failed normal utility power source. This standby rating allows varying loads, with no overload capability, for the entire duration of utility power outage. "PRIME RATINGS" are strictly for gen-sets that provide the prime source of electric power, where normal utility power is unavailable or unreliable. A 10% overload is allowed for a total of 1 hour, within every 12 hours of operation. All gen-set power ratings are based on temperature rise measured by resistance method as defined by MIL-STD 705C and IEEE STD 115, METHOD 6.4.4. All generators have class H (180°C) insulation system on both rotor and stator windings. All factory tests and KW/KVA charts shown above are based on 150°C (maximum), 125°C (standby), and 105°C (prime) R/R winding temperature, within a maximum 35°C ambient condition. Generators operated at maximum power ratings will not exceed the temperature rise limitation for class H insulation system, as specified in NEMA MG1-22.40. Specifications & ratings are subject to change without prior notice.

COOLING SYSTEM

Air cooled by generator and engine suction fans. A maximum 33 CFM cooling intake air is needed for proper engine cooling.

EXHAUST SYSTEM

Residential type muffler with 58 CFM exhaust flow and an exhaust back pressure at 3600 RPM full load, of 44" water column.

ENGINE CLASS AND EMISSION LIMITS

If an engine is not handheld (trimmer, blower, etc.) and is greater than or equal to 225cc displacement, it is a Class II engine. Following are maximum emission levels for CARB & EPA Class II engines.

CALIFORNIA TIER 1 (GRAMS / HP-HOUR)

CLASS	DISPLACEMENT	HC+NO _x	CO
II	20 HP = 614 CC	10	350

USA EPA PHASE 1 (GRAMS / KILOWATT HOUR)

CLASS	DISPLACEMENT	HC+NO _x	CO
II	20 HP = 614 CC	13.4	519

1 HORSEPOWER = .746 KW

1 KW = 1.341 HORSEPOWER

Honda engines are EPA and CARB (California Air Resources Board) certified for LPG and Natural Gas.

DERATING FACTORS

Engine horse power ratings meet SAE J1349 test codes. Reduce 3.5% for each 1000 feet, over 328 feet above seal level and 1% for every 10°F (5.65°C) rise, above 77°F (25°C). Generator specifications are in accordance with ASA, NEMA, and IEEE standards.

ACOUSTIC DATA

A= Access Doors,
B= Engine End cool air
C= Generator End hot air & exhaust exit

Note: All tests are full load operation in standard weather with Open (no enclosure), Standard Enclosure, or Super-Silent Enclosure.

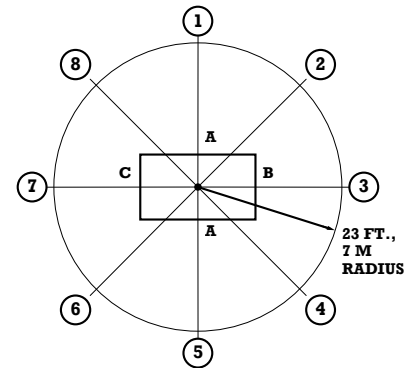

Model SPH-100 O-Open (no enclosure)

Position	1	2	3	4	5	6	7	8
dB(A)	72	71	73	71	72	74	76	74

Model SPH-100 E-Standard Enclosure

Position	1	2	3	4	5	6	7	8
dB(A)	66	66	68	65	66	69	70	69

Model SPH-100 S-Super-Silent Enclosure

Position	1	2	3	4	5	6	7	8
dB(A)	63	63	64	63	63	65	67	66

STANDARD ENCLOSURE FEATURES

- Rust-free "Galvaneel" steel housing.
- Baked-on powder coat paint, having UV protection and 1000 hr. salt spray deterioration test per UL standards.
- Interior sound damping preventing metal "ringing".
- Interior sound absorbing foam throughout enclosure.
- (3) Full service locking access doors.
- Hot muffler is concealed inside enclosure.
- Full steel base for firm-rigid mounting.
- Polymer mounting pad is furnished for easier and faster installation.

ENGINE MONITOR & OPERATION MODE FOR RESIDENTIAL STANDBY GENERATOR SETS

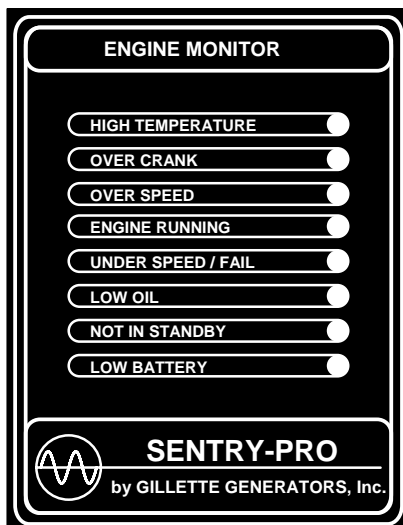

These sets use standard (2) wire start interfacing fully compatible with any dry contact start-stop system that might be installed on ATS, remote start-stop control panels, Trace inverters for controlling solar power battery arrays, etc. The start-stop signal on such equipment is utilized by the gen-set to initialize a (4) second countdown before the gen-set actually begins its first crank cycle, to

avoid start-ups due to momentary power outages.

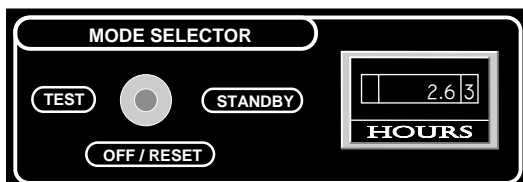

These standby gen-sets are "stand-alone" units which can work with any type ATS system or any other type sensing device, using (2) wire start-stop interfacing.

Standard features of SPH series standby sets are:

Solid State Digital Microprocessor providing automatic engine start-stop; auto shutdown for low oil, high temperature, over speed, under speed, engine fail, engine crank failure (after 3 failed crank attempts); battery charge fail; a "not in standby mode" warning indicator and a built-in (4) second engine start delay and (2) minute engine cool down delay. Timer cycles can be disabled in the field if application requirements so dictate. The "Mode Selector" switch serves (3) functions: A "Test" position (causing the gen-set to start and run indefinitely, without ATS switching the load); a "Standby" position (the system is ready to start automatically, whenever utility power fails); and an "Off/Reset" position (the engine can not start under any condition, so this is the service position and reset position when any fault is corrected). The "Engine Monitor" has (8) highly visible LED annunciators for all conditions. When mode switch is placed in "Standby" all (8) LED's will flash (3) times serving as a lamp test. The panel also includes a mainline circuit breaker and run time meter.

STANDARD AND OPTIONAL FEATURES FOR MODEL SPH-100

CONTROL PANEL:

SPH Series, automatic start-stop engine controller, utilizing solid state digital microprocessor with (8) ultra-bright LED annunciators. Panel also has main line circuit breaker, run time meter, and mode selector switch with “Test”, “Standby”, or “Off/Reset” positions.

ENGINE:

Full flow air cleaner and oil filter • full pressure oil system with separate oil cooler • spin-on oil filter • residential muffler • 12 VDC battery charging alternator • vibration isolators • secondary dry fuel regulator with dry fuel lock-off solenoid • overhead valve Honda engine with EPA/CARB certified dry fuel system

GENERATOR:

AC generator with capacitor regulation system • single bearing • brushless design • class H, 180°C insulation system • self ventilated, drip proof construction

ELECTRICAL:

390 CCA, 12 VDC Battery • battery tray • battery cables • battery straps • 3-stage, float type 2amp auto battery charger

SUPPORT:

Operation, maintenance, and installation instructions
 Call 1-800-777-9639 or Fax 1-574-262-1840
 E-mail : sales@gillettegenerators.com
 Web : www.gillettegenerators.com

OPTIONAL FEATURES & ACCESSORIES

- | | |
|--|--|
| <ul style="list-style-type: none"> <input type="checkbox"/> Remote annunciator <input type="checkbox"/> 3 Phase winding <input type="checkbox"/> 3 Phase ATS system <input type="checkbox"/> 1 Phase ATS system <input type="checkbox"/> Open (no enclosure) for special applications | <ul style="list-style-type: none"> <input type="checkbox"/> Super-Silent housing w/ special sound deadening foam <input type="checkbox"/> “Resonator” muffler added to existing residential muffler, to reduce high pitch exhaust tones <input type="checkbox"/> Crankcase oil heater for faster cold weather starts <input type="checkbox"/> All aluminum weather housing |
|--|--|

DIMENSIONAL OVERVIEW PRINT FOR MODEL SPH-100

DRAWING NOT TO SCALE & DIMENSIONS = IN [MM]

LIFTING HOLES:
 HAVE VENTED PLASTIC HOLE PLUGS INSTALLED. AFTER REMOVING PLUGS FOR LIFT RODS, REMEMBER TO REINSTALL PLUGS.

DRY FUEL CONNECTION:
 LPG OR NAT. GAS CONNECTION IS LOCATED ON THE ENGINE END PANEL AS SHOWN. THERE IS A 3/4" THREADED PIPE WITH COUPLER FOR CONNECTION.

ELECTRICAL CONNECTION:
 THERE ARE TWO KNOCK-OUT HOLES ON THE RIGHT HAND SIDE OF GENERATOR END. BOTH HOLES ARE FOR 3/4" CONDUIT. ALSO, THERE ARE TWO HOLES IN FRAME INSIDE CONNECTION BOX, WHICH CAN BE USED FOR STUB-UP WIRING.

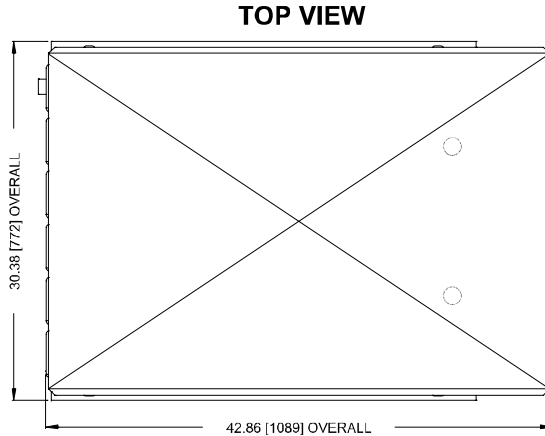

NOTE: DESIGN & SPECIFICATIONS SUBJECT TO CHANGE WITHOUT PRIOR NOTICE. DIMENSIONS SHOWN ARE FOR REFERENCE ONLY AND SHOULD NOT BE USED FOR PLANING INSTALLATION. CONTACT GILLETTE FOR CERTIFIED DRAWINGS.

INSPECTION PANEL:
 THIS PANEL IS HERE TO HELP WITH INITIAL INSTALLATION AND QUICK ACCESS TO GENERATOR END FOR REPAIR INSPECITON. DO NOT REMOVE PANEL WHILE UNIT IS HOT OR RUNNING.

EXHAUST CHUTE:
 LOCATED IN THIS CHUTE, IS THE EXHAUST PIPE OF MUFFLER PLEASE KEEP CLEAR WHILE UNIT IS RUNNING OR HOT. DO NOT INSTALL UNIT WHERE THE EXHAUST MAY COME INTO CONTACT WITH FLAMMABLE OBJECTS.

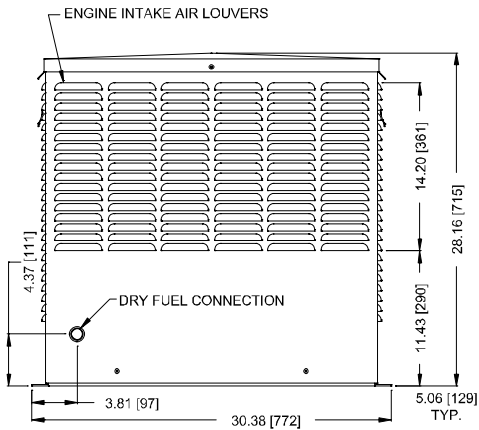

ENGINE END VIEW

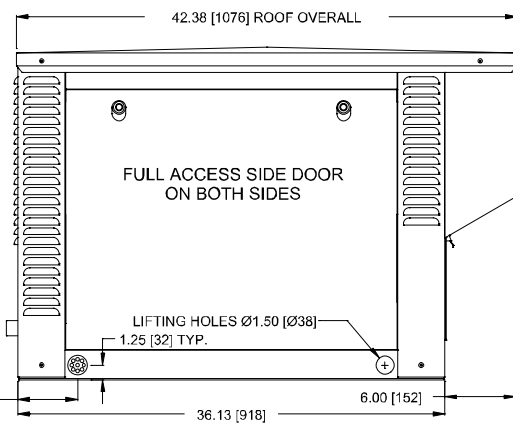

SIDE VIEW

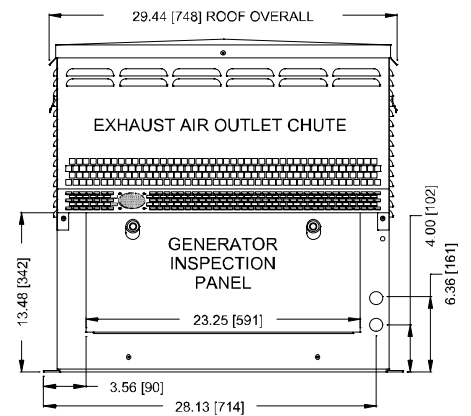

GENERATOR END VIEW

DIMENSIONS AND WEIGHTS

	Open Set	Standard Enclosure	Super-Silent Enclosure
Length in (cm)	36 (91)	43 (109)	43 (109)
Width in (cm).....	31 (79)	31 (79)	31 (79)
Height in (cm).....	25 (64)	28 (71)	28 (71)
Net Weight lbs (kg).....	300 (136)	415 (188)	440 (200)
Ship Weight lbs (kg).....	350 (159)	465 (211)	490 (222)

DISTRIBUTED BY:

